

## TGD2 Standard Rope Guard Installation SRG30-TGD2-Long (V3)

### Parts List

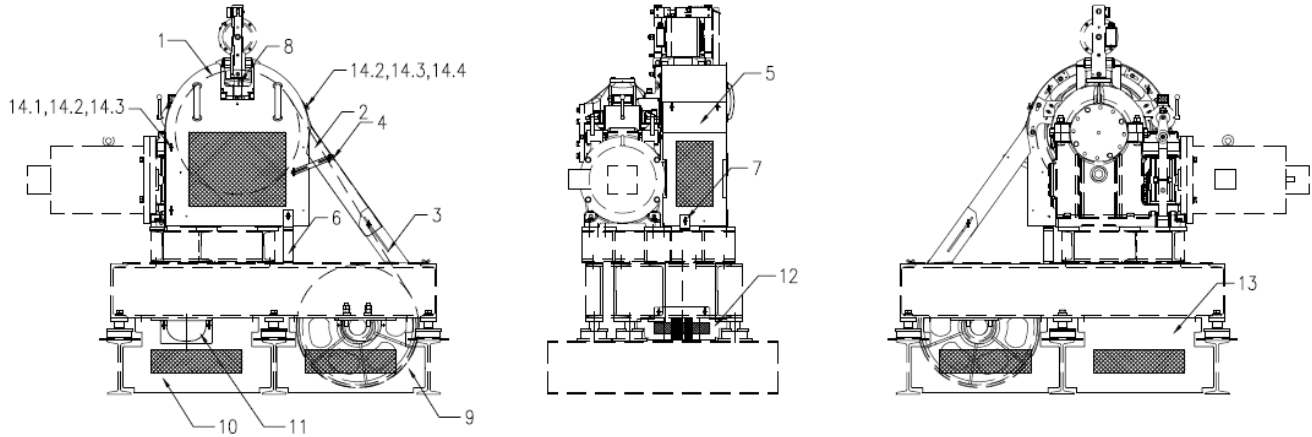

### Bill Of Material

#	Part	Description	Qty.
1	SRG-TGD2-001	TGD2 Main Sheave Guard	1
2	SRG-TGD2-002	TGD2 Deflector Side Upper Rope Guard	1
3	SRG-TGD2- Long-001	TGD2 Deflector Side Lower Rope Guard	1
4	SRG-TGD-001	TGD Rope Guard Support Plate	1
5	SRG-TGD2-003	TGD2 Car Side Rope Guard	1
6	SRG-TGD2-004	TGD2 Rope Guard Long Bracket	1
7	SRG-TGD2-005	TGD2 Rope Guard L Bracket	1
8	SRG-TGD2-006	TGD2 Sheave Brake Cover	1
9	SRG-SBLT-Long-001	Deflector Sheave Guard for SBLT-Long-TGD/TMGL-Right	1
10	SRG-SBLT-Long-002	Deflector Sheave Guard for SBLT-Long-TGD/TMGL-Left	1
11	SRG-SBLT-Long-003	Deflector Hole Cover for SBLT-Long-TGD/TMGL	1
12	SRG-SBLT-001	Bedplate Side Guard for SBLT-Long-TGD/TMGL and SBLT-Short-TGD	2
13	SRG-SBLT-Long-004	Bedplate Back Guard for SBLT-Long-TGD/TMGL	2
14	SRG-HDW-TGD	Hardware kit for TGD1/TGD2 Rope Guard	1
		14.1 Wing Bolts M6x16	30
		14.2 Lock Washer Ø6	34
		14.3 Flat Washer Ø6	34
		14.4 Wing Nut M6	4
		14.5 Beam Clamp	2

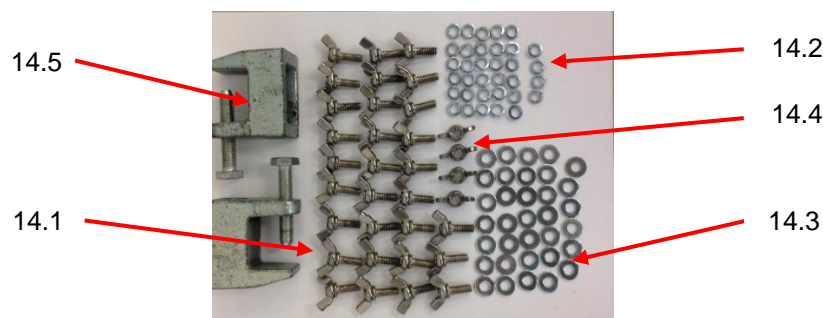

## Assembly Instructions

**Step 1:** Install Main Sheave Guard [#1] to Rope Retainer using (2) wing bolts, flat washers, and lock washers. See Figures 1 and 2.

**Step 2:** If applicable, Install Sheave Brake Cover [#8] to Rope Retainer and Main Sheave Guard [#1] using (3) wing bolts, lock washers, and flat washers. See Figures 2 and 3.

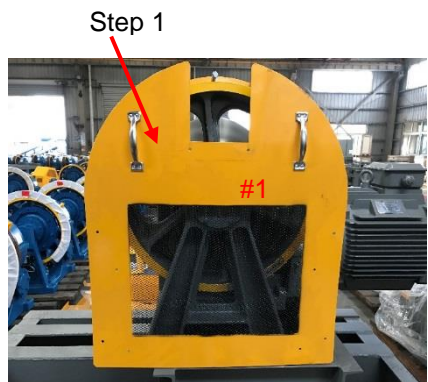

Figure 1 - Install Main Guard

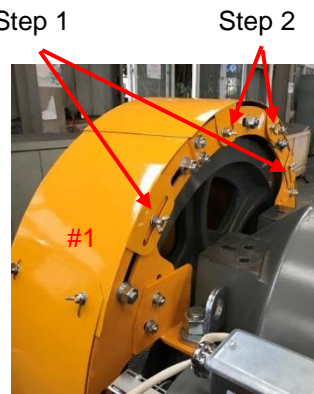

Figure 2 - Install Main Guard & Sheave Brake Cover

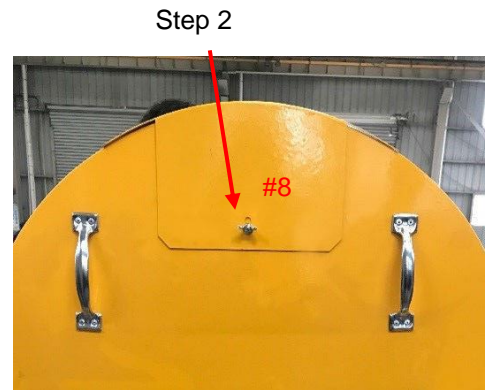

Figure 3 - Install Sheave Brake Cover

**Step 3:** Install Car Side Rope Guard [#5] to Main Sheave Guard [#1] using (2) wing nuts, (2) wing bolts, and (4) lock washers and flat washers. Then Install L Bracket [#7] to the Car Side Rope Guard and the machine base using (1) wing bolt, lock washer, flat washer and beam clamp. Also install Long Bracket [#6] to Main Sheave Guard and machine base using (1) wing bolt, lock washer, flat washer and beam clamp. See Figure 4.

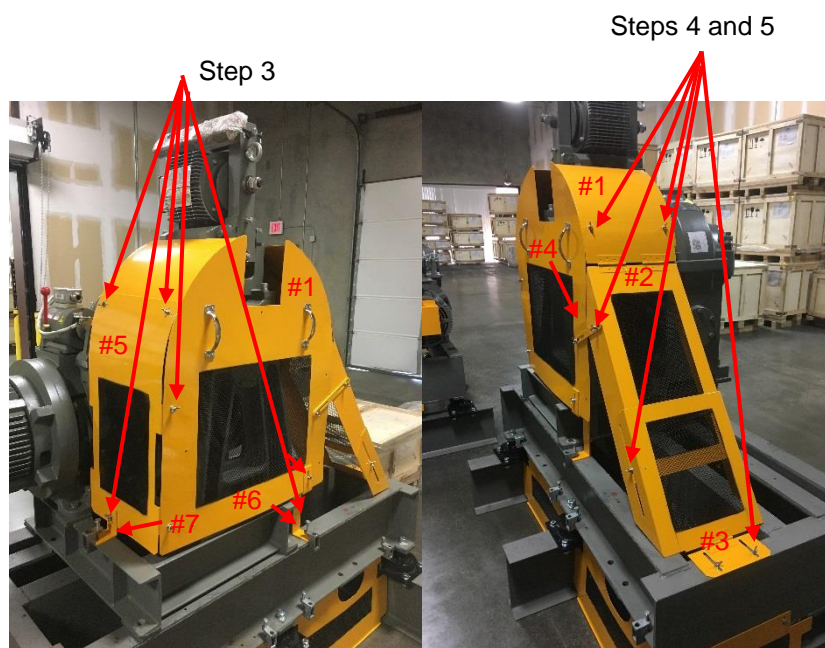

Figure 4 - Install Car Side and Deflector Side Rope Guards

**Step 4:** Install Deflector Side Upper Rope Guard [#2] to Main Sheave Guard [#1] using (2) wing nuts, flat washers, and lock washers. Then attach Deflector Side Lower Rope Guard [#3] to Deflector Side Upper Rope Guard and Bedplate using (4) wing bolts, flat washers, and lock washers. See Figure 4.

**Step 5:** Attach the Support Plate [#4] to the Main Sheave Guard [#1] and the Deflector Side Upper Rope Guard [#2] using (2) wing bolts, flat washers, and lock washers. See Figure 4.

**Step 6:** Install Deflector Sheave Guard Right [#9], Deflector Sheave Guard Left [#10], (2) Bedplate Back Guards [#13] (not shown), and (2) Bedplate Side Guards [#12], to the bedplate using (2) each wing bolts, lock washers, and flat washers. (Right hand machine is shown as an example.)

**Step 7:** Install Deflector Hole Cover [#11] to the appropriate Deflector Sheave guard using (2) wing bolts, lock washers, and flat washers.

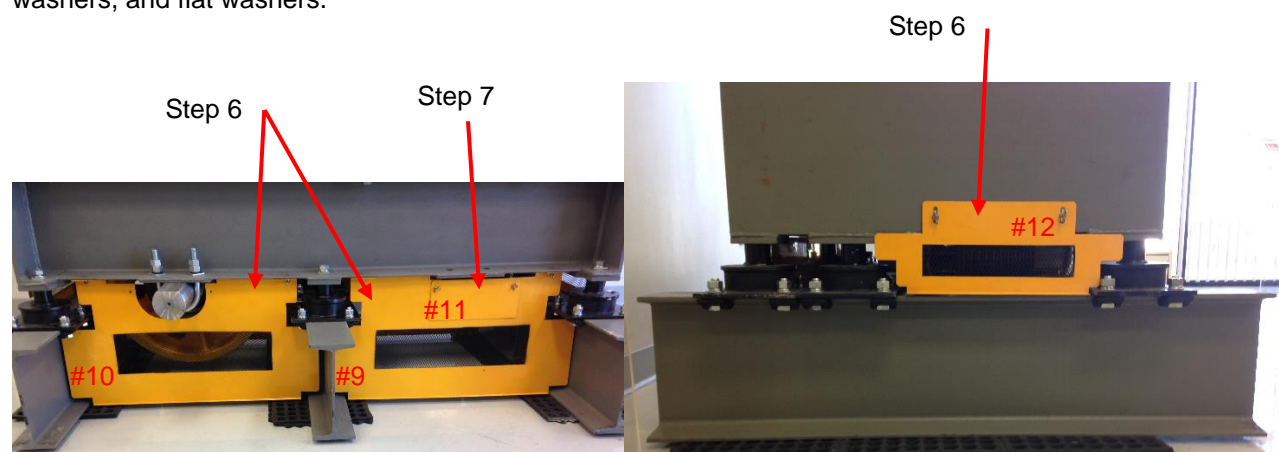

Figure 5 – Install Deflector Guards